



Instructions for laying steel pipes with welded joints



These pipe-laying instructions contain information about laying and field-coating steel pipes with welded joints. They supplement the generally accepted technical rules in force, e.g. EN 805 and DVGW Worksheet W 400 for water pipelines and EN 12007 and EN 1594 with DVGW Technical Rules G 462 and G 463 for gas pipelines.

- [Transportation and storage](#)
- [Pipe trench and bedding](#)
- [Stringing](#)
 - [Pipe joints](#)
 - [Welding pipes](#)
 - [Field coating](#)
 - [Field top coating](#)
 - [Field cutting](#)
 - [Field lining](#)
 - [Directional changes](#)
 - [Coating Test](#)
 - [Repairs](#)
- [Trenchless pipe-laying](#)
 - [Field coating](#)
 - [Pipe end design](#)
- [Pressure test](#)
- [Saddle fittings](#)

Transportation and storage

Pipeline components must be protected from damage. They should never be handled with sharp-edged lifting devices or steel ropes. Only equipment that ensures impact-free lifting and lowering may be used. Pipes must not be dropped or rolled.

Lifting tackle must be such that damage to the pipeline components and the coating is avoided (e.g. wide belts, padded ropes). Pipes fitted with handling caps can be lifted by the pipe ends with suitable hooks. The lifting tackle must be appropriately spaced to rule out impermissible sagging (and resultant deformation).

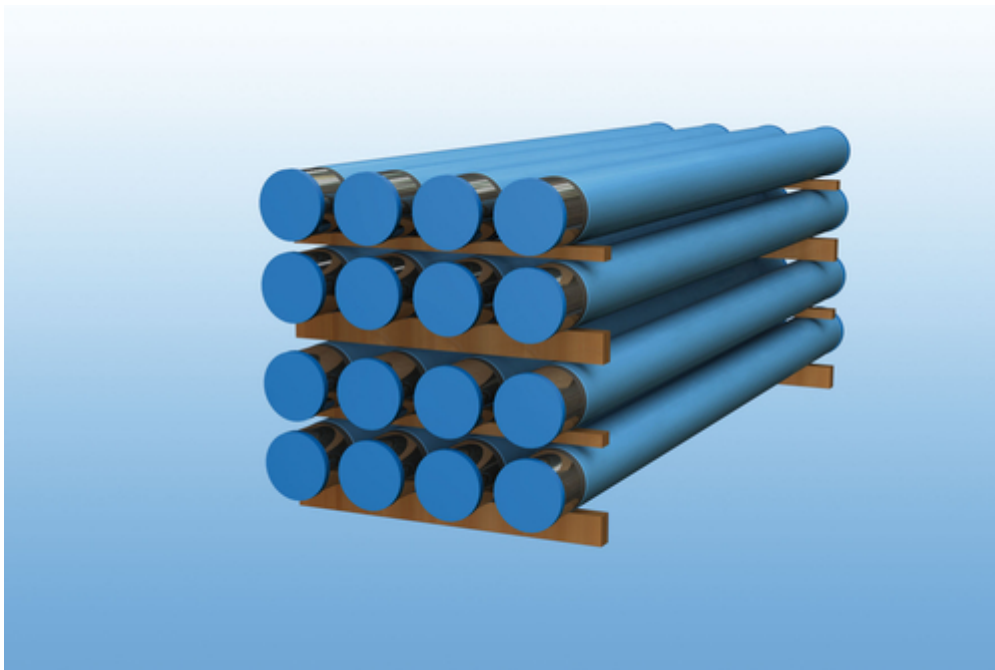

During transportation and storage, the pipeline components must be suitably separated and secured to prevent rolling, shifting, sagging and vibration. They should be stacked according to their lengths, e.g. on several planks or beams at least 100 mm in width, preferably using the wooden dunnage supplied with the pipes.

Loading areas must be free of burrs and sharp edges and, if necessary, must be padded to avoid damage. Pipeline components must be kept capped until they are laid so that they cannot be contaminated by soil, mud, dirty water, etc.

Supports and stack heights must comply with the applicable accident prevention regulations and rule out damage to the pipeline components. The load-bearing capacity and condition of the soil must be taken into account. The stack height should be between 2.0 and 3.5 meters.

Coated pipeline components with no other external protection such as an FCM coating must be protected from sunlight during storage periods of more than one year.

Pipe trench and bedding

Steel pipes with welded joints can be laid individually or as a prewelded string. Before the pipes are lowered, a solid, uniform bearing must be ensured in the bottom of the trench along the entire length of the pipeline. Point supports must not be used, due to the resulting uneven pressure distribution. Joint holes must be prepared in such a manner the joints can be properly made up and tested:

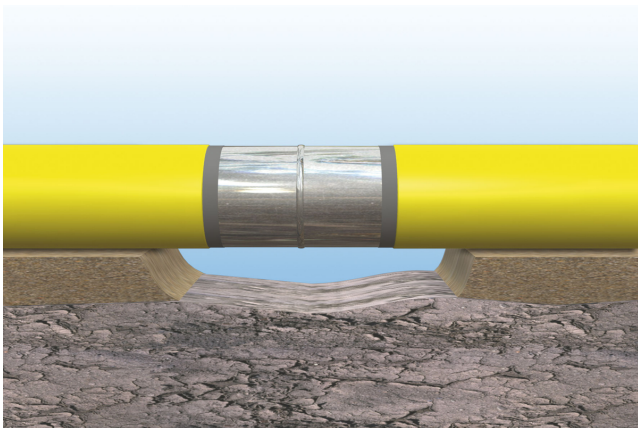
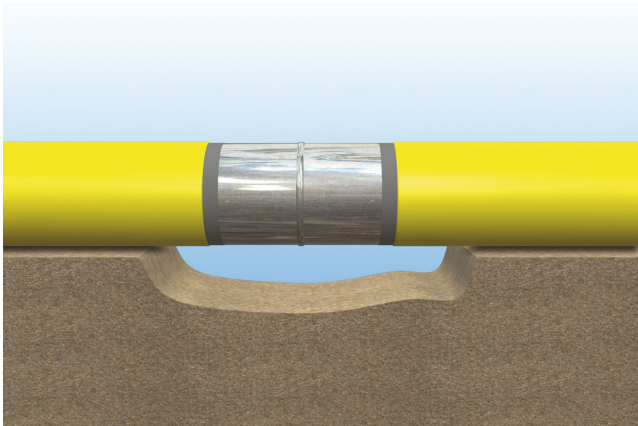

Usually the excavated spoil is a suitable support. If the pipes are plastic coated, they must not be laid directly on stony ground or rock. In such cases the pipe trench must be dug deeper so that a layer of suitable stone-free compactable material can be added. If the trench as dug is not suitable for bearing loads, other safety measures may have to be taken.

Polyethylene- and polypropylene pipes is shown in the PDF file which you can download below coated pipes must be bedded in stone-free material. Suitably deep layers of sand, gravelly sand, sieved soil or other suitable materials can be used for this purpose and compacted if necessary. Depending on the laying conditions and the bedding material, the following particle sizes are recommended:

Pipe-laying with compaction		Pipe-laying without compaction	
Round grain (sand/gravel)	Crushed grain (stone/shingle)	Round grain (sand/gravel)	Crushed grain (stone/shingle)
0 to 4 mm max. 8 mm	0 to 5 mm max. 8 mm	0 to 8 mm max. 16 mm	0 to 5 mm max. 8 mm

The bedding materials and grading curves specified above are recommendations in accordance with the listed standards. Other bedding materials with comparable properties or proven suitability for use in the given conditions can also be used.

For steel pipes with a polyethylene coating and additional FCM top coating, the excavated material can be used to backfill the trench. If compacting is specified, the material must be compactable and the cover height must be at least three times the size of the largest grain in the backfill material.

Stringing

- Pipe joints
- Welding pipes
- Field coating
- Field top coating
- Field cutting
- Field lining
- Directional changes
- Coating Test
- Repairs

Pipe joints

Two types of welded joints can be used: the butt weld and the slip welding joint:

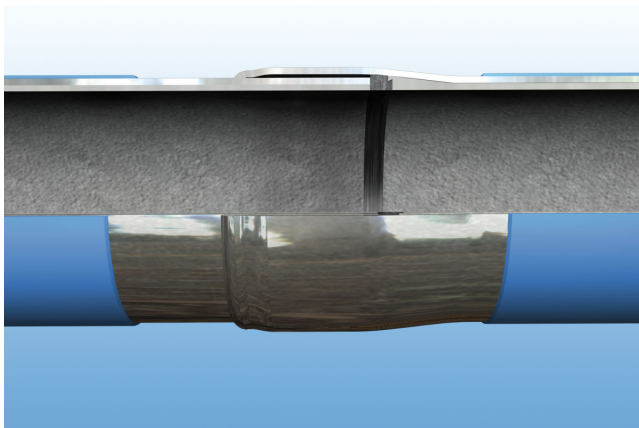
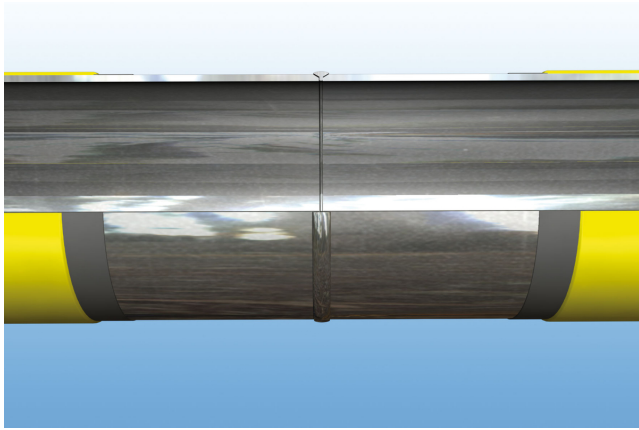

As a rule, pipes with butt weld joints are used for gas and drinking water pipelines; with aggressive aqueous media the slip welding joint can be used as an alternative. The advantage of the latter is a continuous internal protection of the pipe string.

In addition, the use of non-permanent, mechanical connections (coupling and flange connection) is possible in particular for exposed joints. More information can be found [here](#).

Welding pipes

Information on the production, testing and assessment of welded joints is set out in EN 12732 and in DVGW Worksheet GW 350.

The requirements to be met by the welding company, for example in relation to the quality assurance system, depend on the intended pipeline service area and the associated quality level (A to D). The welders must have passed a qualification test to EN 287-1 for the welding techniques, materials and dimensions concerned and must hold a valid examination certificate.

Suitable welding techniques, depending on the requirements and welding conditions, are manual metal arc welding (process 111 according to ISO 4063), TIG welding (process 141), metal active gas (MAG) welding (process 135) and oxy-acet welding (with oxygen-acetylene flame, process 311).

The most commonly used field welding process is manual arc welding with a coated electrode. ISO 2560 specifies the use of basic or cellulose coated electrodes. The process is used for all welding passes (root, filler and cap passes) and positions and is particularly well-suited for vertical-down welding. In addition, the good protective atmosphere is a great advantage in field welding.

Both the TIG and MAG welding processes are limited in their suitability for field welding due to the sensitivity of the protective gas atmosphere to weather influences. They are therefore more appropriate for workshop welding. Their high degree of automation makes both processes popular for orbital welding, with TIG welding also being used for root passes in view of the high weld efficiency it can achieve.

Gas fusion welding is used for pipe sizes up to DN 150 in all welding positions except vertical-down. Generally, it tends to be less commonly used because of its relatively low cost effectiveness.

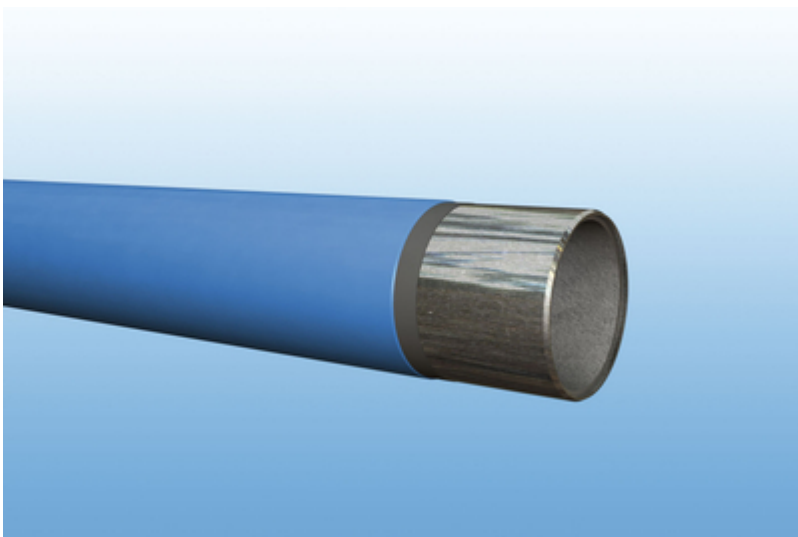

Water line pipe

Water line pipes are generally welded with the same welding parameters as gas line pipes. The cement mortar lining in water line pipes means, however, that some additional points have to be considered.

Butt weld joints in particular should be executed only by manual arc or TIG (for the root pass) welding because of the lower heat input.

When water line pipes are joined by manual arc welding with cellulose-coated electrodes, an ISO-2560-compliant E 42 2 C 25 electrode is used (e.g. Thyssen CEL 70 up to 360 N/mm² yield strength).

In order to limit the heat input, the root pass must be welded at the minus pole using the lowest possible welding current. The lower pipe sections (i.e. from the 3 o'clock to the 6 o'clock and from the 9 o'clock to the 6 o'clock positions) should be welded first and only then the upper half of the pipe. Filler and cap passes are welded from 12 to 6 o'clock.

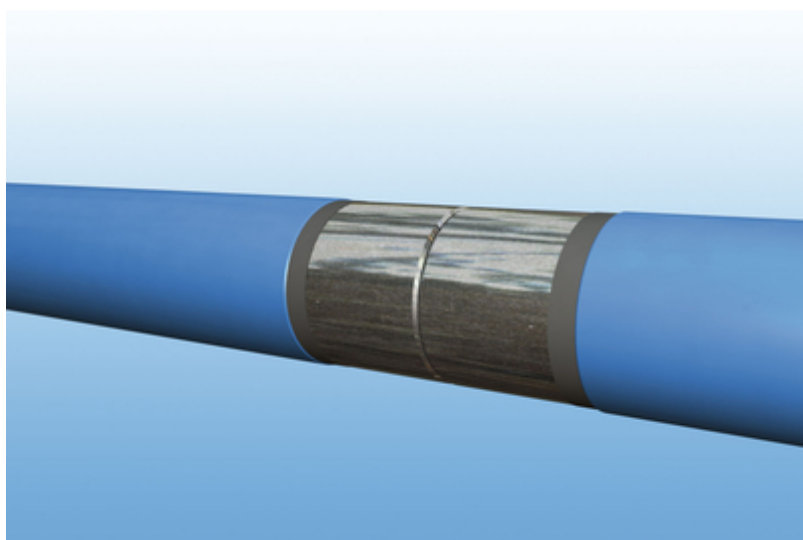

Making up a welded joint

1. Before welding, the edges must be cleaned to remove any surface protection, rust and dirt. This includes removing the coating (complete with adhesive) over an area of 10 times the wall thickness, or at least 100 mm.
2. Couplings (in pipes with slip welding joint) and collars (in pipes with sleeve joint) must be heated to forging temperature if necessary and the entire circumference prepared over a length of at least 30 mm in such a way that the gap at the root is kept as small as possible (tight fit).

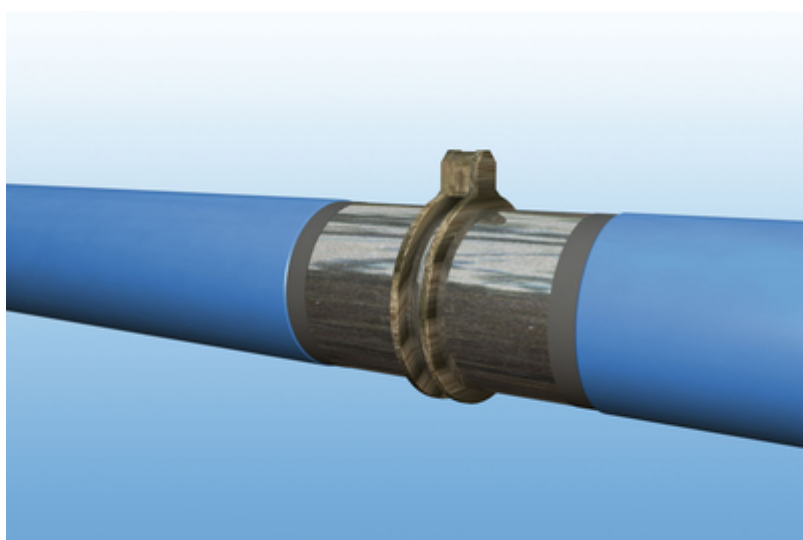

3. Install the centering device. For pipes up to about DN 300, external line-up clamps should be used. This allows the entire root pass to be welded without loosening the clamps. For larger pipe sizes and wall thicknesses, it may be advisable to use a pneumatic or hydraulic internal centering device.

4. Depending on the welding conditions and the pipe material used, the pipe ends may have to be preheated as specified in the welding instructions.

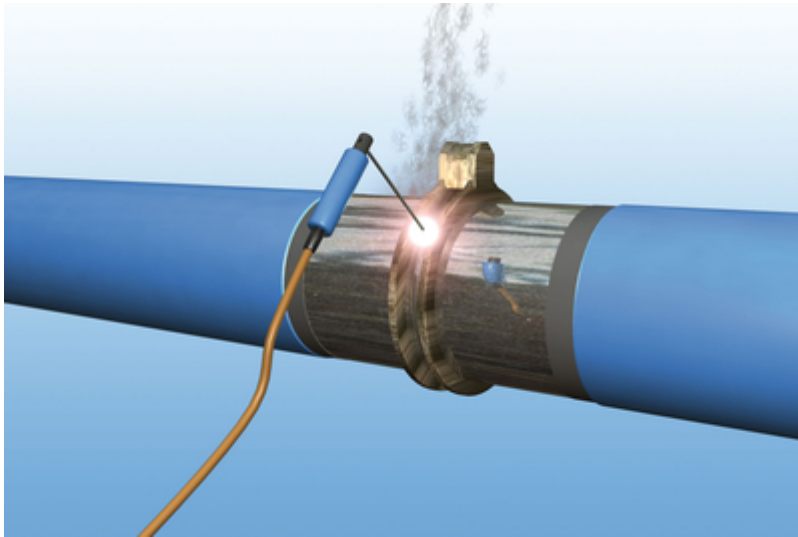

5. Welding the pipe ends: The weld area must be kept free of detrimental influences (e.g. dust, dirt, grease and water) and protected from rain and wind. The welds must be executed in a minimum of two passes (single-pass welds are permissible in the case of gas fusion welding up to a pipe wall thickness of about 3.6 mm). Welding must be performed swiftly and without any significant interruptions up to the cap pass.

Recommended welding current as a function of the electrode diameter:

	Electrode diameter (mm)	Current (A)
Root pass	2.5 bzw. 3.2	50-80 bzw. 80-130
Filler or cap pass	4.0	120-180

Gas line pipe

The recommendations for the welding of water line pipes also apply to gas line pipes. However, when welding higher-strength grades as per ISO 3183 in particular, account must be taken of the specific alloy properties and processing behavior.

The welding parameters and the required post-weld measures, e.g. protection against humidity, must be adapted to the material thickness, heat input and preheating temperature and defined accordingly in the welding instructions.

Field coating

The plastic coating in the joint area is completed with corrosion protection wrappers (polyethylene, butyl rubber or combinations) or heat-shrink material (shrink-on collars, heat-shrink tubes or hot-applied tapes) in accordance with DIN 30672. Special applications may also call for polyurethane/epoxy resin fillers. Field coating material for pipelines with cathodic protection must be selected in compliance with DIN 12068. The manufacturer's instructions must always be followed.

Field coating systems are applied either hot or cold. They are designed for pipeline operating temperatures of 30°C or 50°C. In addition, they are subdivided into load classes A, B and C, with class C material featuring the highest loadability.

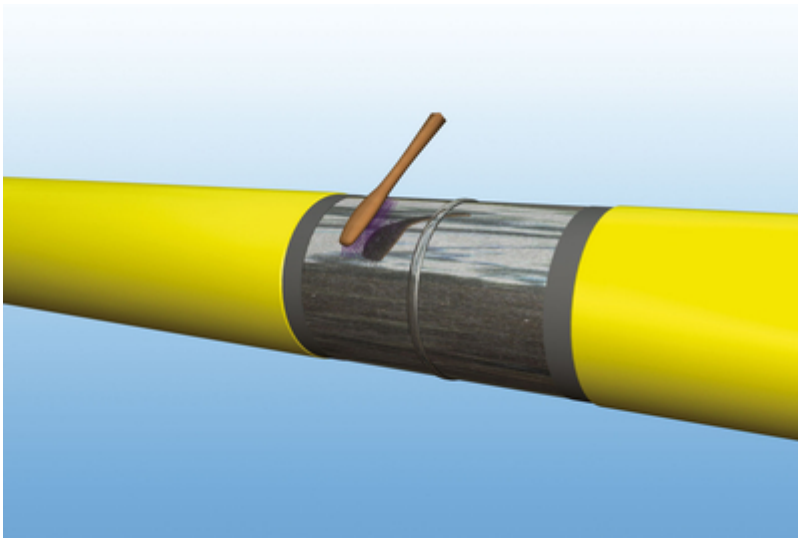

Example: Field coating with cold wrappers

1. Preparatory steps: Pipe and mill-applied coating must be cleaned of dirt, oil and grease and the temporary corrosion protection coat removed. The adhesive and the epoxy resin layer of the plastic coating can remain on the pipe. Bevel the edges of the mill-applied coating to an angle of 30°.

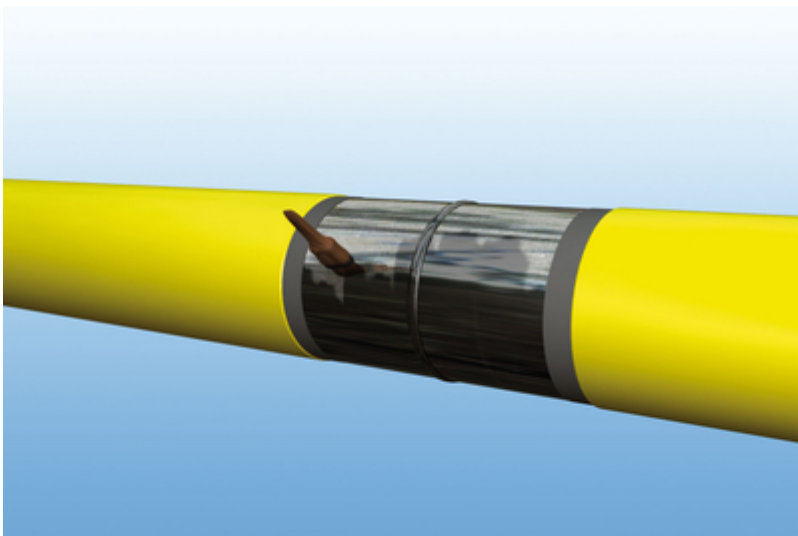

2. Apply primer in accordance with the manufacturer's instructions. It may be necessary to let the surface dry before applying the primer. Observe flash-off time requirements before wrapping the anti-corrosion tape round the pipe joint.

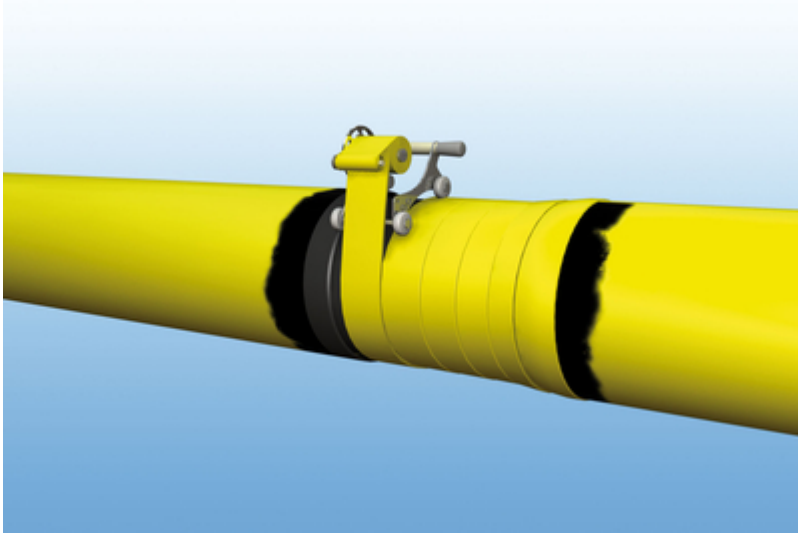

3. The anticorrosion tape is applied spirally, pulling it tight as it is wrapped around in either one or two layers, depending on the tape used. Each wraparound must overlap the previous layer by 50 percent as instructed by the manufacturer, with an all-round overlap of at least 50 mm over the mill-applied coating.

Field top coating

The fiber cement mortar top coat serves as a mechanical protection for the plastic coating. FCM coatings are produced according to DIN 30340-1. FCM-coated pipes should be handled in basically the same manner as pipes with plastic coating.

DIN 30340-1 distinguishes between two types of coating, the FCM-N (normal type) for open-trench laying and the FCM-S (special type) coating for the various trenchless pipe-laying techniques. Pipes for trenchless laying are specially treated to give them an adhesive bond between the plastic coating and the FCM top coat. Shear forces that arise during laying can thus be safely transferred.

Field coating with casting mortar

The casting mortar is supplied in buckets of two different sizes. Bucket size A contains enough casting mortar for two DN 100 field coatings or 1 field coating for DN 250 to DN 500 pipe. Bucket size B contains enough casting mortar for two DN 150 or DN 200 field coatings or 1 field coating for DN 350 or DN 400 pipe, respectively. Buckets for DN 500 and/or DN 600 field coatings are available on request. As the setting time depends on the temperature, two different mortar mixes are available:

Winter mortar: processing temperature +5 °C to approx. +15 °C

Summer mortar: processing temperature +10 °C and approx. 30 °C

The cement mortar should not be used at temperatures below 0°C, since it has to harden in a frost-free environment. If there is a risk of frost, additional protective measures must be taken (e.g. thermal insulation). The field coating system is made up as follows:

- Cement mortar (special dry mortar and water)
- Special cardboard moulds (standard width 500 mm)
- Adhesive tape for fixing the mould round the pipe

Tools and equipment to be provided by the user:

- a drilling machine with mixer attachment
- scissors or knife for cutting the adhesive tape

The field coating can be applied by one person alone. As the mortar sets very quickly, the field coated joints along the pipe string are ready for pipe-laying including the related stresses after only three hours.

In the case of trenchless pipelines, the field coating should be given at least 24 hours to set. Further details are to be found under "Trenchless pipe-laying".

At high temperatures or under direct insolation, the field coated areas should be covered with a damp cloth in order to avoid premature drying and shrinkage cracks.

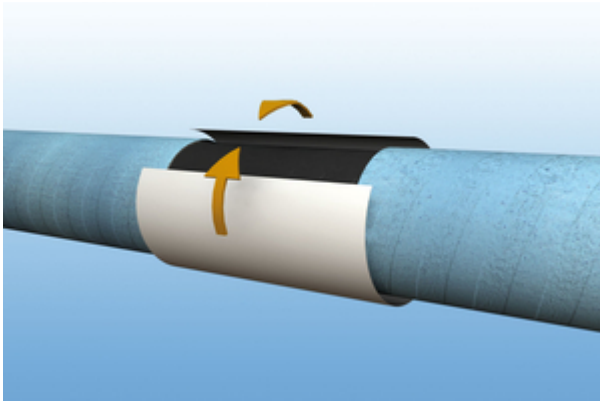

Field coating procedure

1. Slip the mould under the pipe and align it around the circumference of the field-coated joint area.

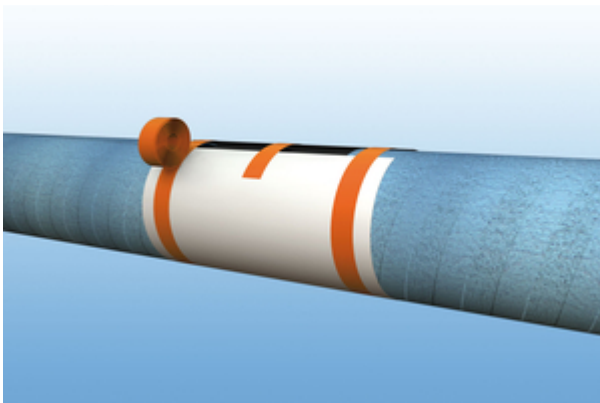

2. Use the supplied adhesive tape to fix the mould in the centre of the filling slot. This ensures a uniform annular space around the pipe. Secure the mould in position with adhesive tape. Pull firmly, lapping the tape around the circumference at both ends of the mould to seal it off.
3. Check that the mould sits firmly around the pipe circumference and make sure that there is no bend in the area of the filling slot. For pipe diameters of DN 100 to DN 200, two moulds must be prepared before mixing the mortar.



4. Take the water container out of the bucket, loosen the dry mix and pour the supplied mixing water into the bucket. Use the mixer attachment for a smooth, homogeneous mixture without lumps.

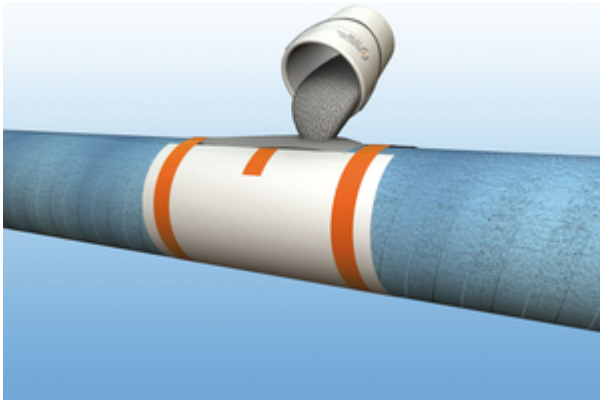

5. Pour the mix into the mould. Leave the mould in place to allow the mortar to set properly.

Field coating with cement wrappers

The cement wrapper is a cement-mortar-coated tape. Waterproof gloves must be worn when handling it. The wrappers are used wherever casting mortar cannot be used, e.g. for fittings or socket joints.



1. Immerse the cement wrapper in cold water until it is thoroughly soaked.



2. Carefully squeeze out any excess water.

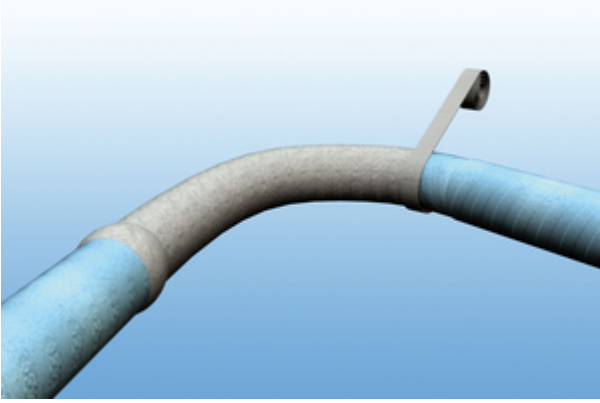

3. Pulling gently, wrap the wrapper around the field-coating area, making sure each wraparound overlaps 60% of the previous layer. After about three hours, the area can take all the stresses involved in pipe-laying.

Field coating of pipe bends with CM wrappers (300 x 12 cm)

Pipe bend to DIN 2605	Number of rolls requires					
	15°	30°	45°	60°	75°	90°
DN 100 1.5 D _a	2	2	2	2	2	2
DN 100 2.5 D _a	2	2	2	2	2	2
DN 150 1.5 D _a	2	3	3	3	4	4
DN 150 2.5 D _a	3	3	3	4	4	4
DN 200 1.5 D _a	3	4	4	4	5	5
DN 200 2.5 D _a	4	4	5	5	6	7
DN 250 1.5 D _a	4	4	5	5	7	7
DN 250 2.5 D _a	4	5	7	8	9	10
DN 300 1.5 D _a	4	5	7	8	9	10
DN 300 2.5 D _a	5	6	9	10	12	14
DN 400 1.5 D _a	6	6	8	10	11	12
DN 400 2.5 D _a	7	9	11	13	15	18

Field coating of butt-weld, slip-welding joints with CM wrappers (300 x 12 cm)

	Number of requires rolls	
Pipe	Butt-weld	Slip-welding joint
DN 100	2	1
DN 125	2	-
DN 150	2	2
DN 200	3	2
DN 250	3	3
DN 300	3	3
DN 400	5	4
DN 500	7	6
DN 600	8	8

Field cutting

The following procedure should be followed:

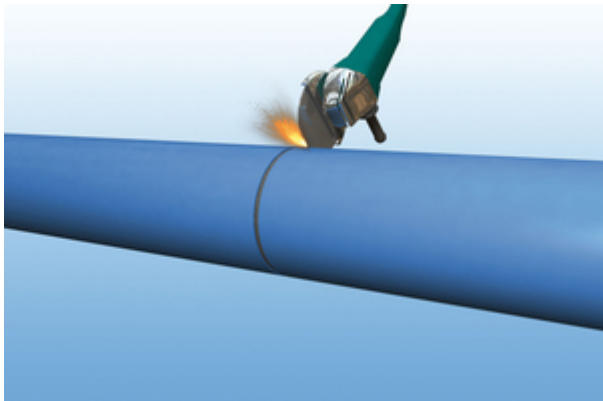

1. Use an abrasive cutter powered either by a petrol motor, an electric motor or compressed air. Abrasive wheels for A 24 steel are recommended.

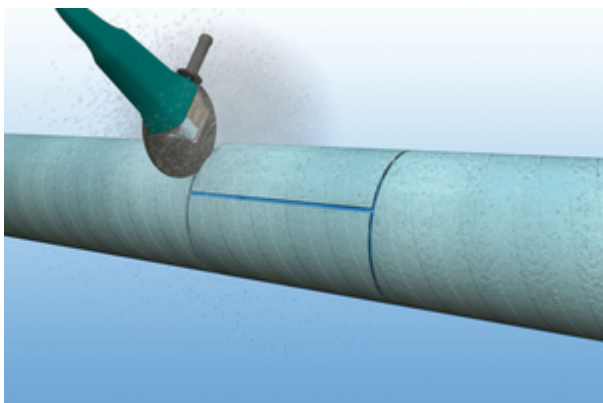

2. To remove the fiber cement coating, e.g. at the end of shortened pipes, or in order to apply saddle fittings on the polyethylene coating, make incisions into the FCM coating around the pipe circumference and along the length to be removed. To avoid damaging the polyethylene coating, make sure that the cutting depth does not exceed 3-4 mm. A suitable attachment for a commercially available angle grinder can be supplied for this purpose (see list of accessories). The fiber cement mortar coating can then be knocked off easily with a hammer.

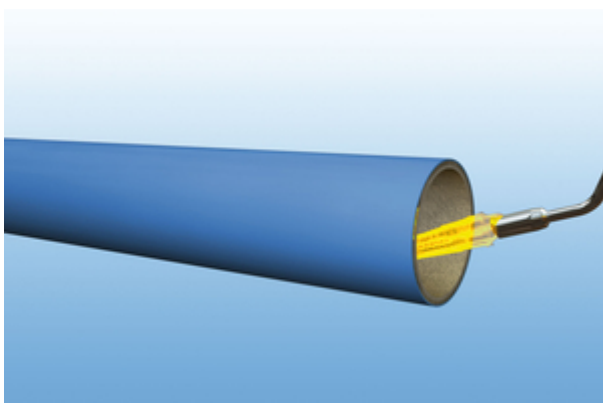

3. Heat the pipe end with a propane gas flame to about 70 °C from inside the pipe. This heats the pipe uniformly without damaging the plastic coating.

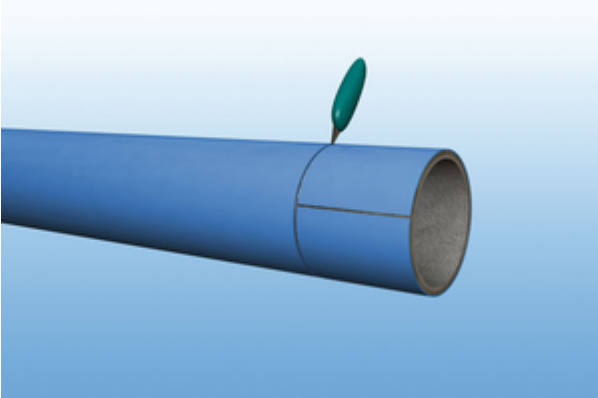

4. Cut along and round the plastic coating. The length to be stripped off the pipe end is approx. 110 mm on butt-weld joints and between 165 and 210 mm on pipes with slip-welding joints, depending on the pipe dimensions (i.e. original pipe end).

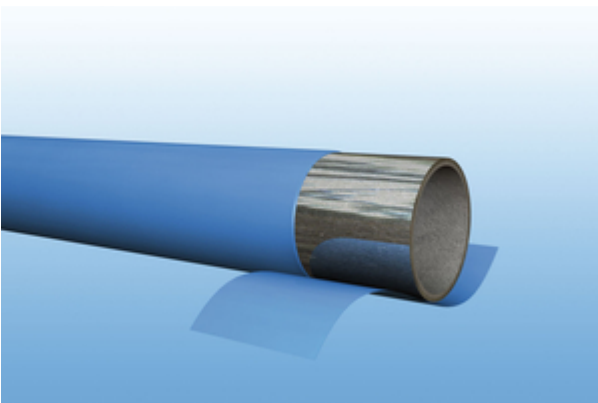

5. Remove the polyethylene coating. At the correct surface temperature the plastic coating pulls off easily and smoothly. If the pipe end coating tears, leave it to cool for a while. If the plastic cannot be easily removed, heat it for a little longer (check with temperature gauge from pipe-laying kit; see list of accessories).

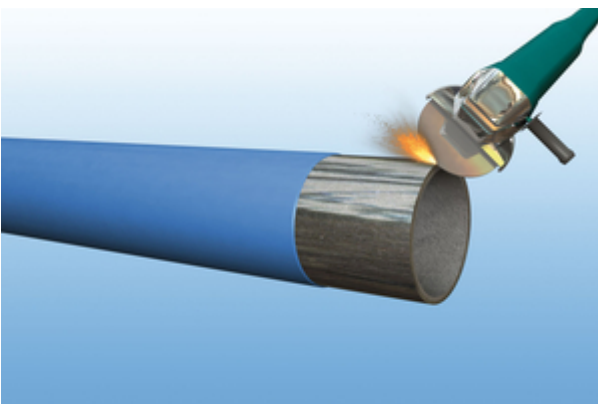

6. Pipe end beveling: With butt weld joints, bevel the pipe end to about 30° with an angle grinder. The residual wall thickness (web height) should be about 1.6 mm. Pipe ends with slip welding joints must not be beveled. Use a grinding disc to remove any residual epoxy resin primer or coating adhesive on the pipe as necessary.

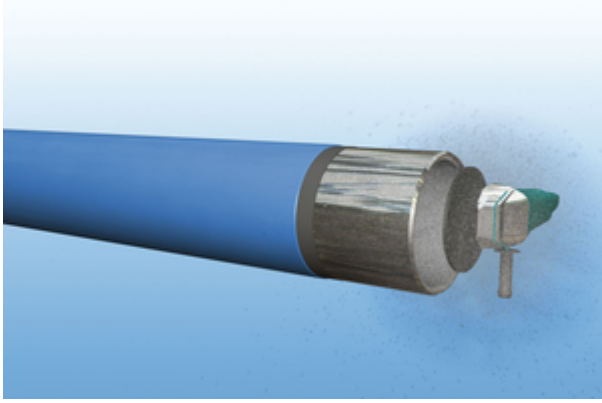

7. Before butt welding water line pipes, cut back the cement mortar lining 3-5 mm at the pipe ends using a special angle grinder attachment (see list of accessories).

Field lining

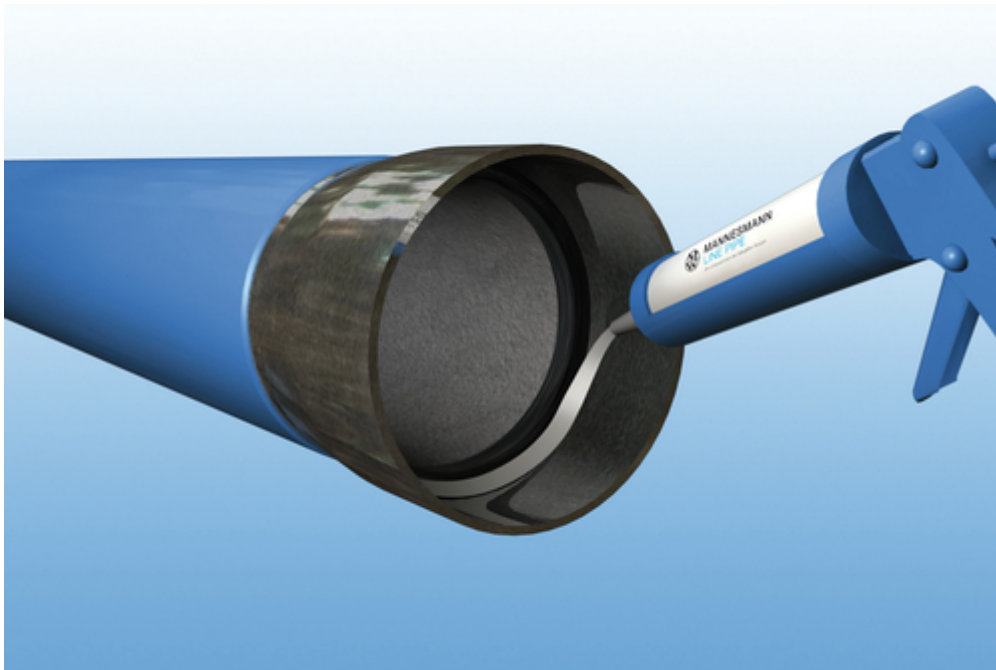

Pipes with slip welding joints to be used with aggressive waters can be protected by an additional sealant. The material, which is supplied in normal commercial cartridges, is applied to the joint with a cartridge gun before the pipe ends are joined. The list of accessories provides information on the quantities of materials required.

Provided the given quantities are used, no further steps are required once the pipes are aligned for welding. Also, there is no need for pigging the joint.

The lining material depends on the water quality. A polyurethane-based material is used for wastewater line pipe and a silicon-based material for natural water to be treated to potable water standards.

Directional changes

The following options for directional changes can be taken when laying the pipes:

1 Utilization of the permissible elastic deformation in the pipeline

As regards bending radii, two application cases can be distinguished:

- On-site handling
- Bending radii in a lowered pipe string (in situ)

During handling on the construction site, the only load to be considered is the bending load. Under operating conditions, the pipe string is subject to a combined load of internal pressure and bending.

On-site handling

The formula below applies to on-site handling of both gas line pipe and cement mortar-lined water pipe:

$$R_{\min} \text{ (m)} = 105 \times D_a \times S/R_p$$

For a material with a yield strength of 235 N/mm² and a safety factor of 1.1 (see below), the rule of thumb for the bending radius (in m) is 500 x D_a.

Bending radii in a lowered pipe string

DVGW Worksheets G 642 and G 463 contain the principles for calculating the permissible elastic bending radii for gas line pipe along the pipeline route.

Provided the calculated permissible elastic bending radii are not exceeded, the maximum design pressure (MDP)* of the pipe is maintained. This applies in principle also to water pipelines.

Water pipelines/ Gas pipelines with MOP < 16 bar	Gas pipelines with MOP > 16 bar
$R_{\min} = 210 \times D_a \times S/R_p$	$R_{\min} = 206 \times D_a \times S/R_p$

R_{min} -min. bending radius in m

R_p - yield strength of pipe material in N/mm²

D_a - pipe outside diameter in mm

S - safety factor

MOP - max. operating pressure

*) Since in most cases regarding gas and water, the operating pressure does not fully utilize the max. permissible design pressure, it may be advantageous to conduct a more accurate calculation that takes account of the actual service conditions, resulting in smaller bending radii.

The safety coefficients and yield strengths to be selected vary according to the pipe material used.

Je nach eingesetztem Rohrwerkstoff sind die Sicherheitsbeiwerte und die Streckgrenzen unterschiedlich zu wählen:

Gas line pipe with MDP < 16 bar			Gas line pipe with MDP > 16 bar			Water pipe line		
Material	S	R _p	Material	S	R _p	Material	S	R _p
L245	1.5	245	L245N/M	1.5	245	L235	1.1	235
L290	1.5	290	L290N/M	1.5	290	L275	1.1	275
L360	1.5	360	L360N/M	1.5	360	L355	1.1	355
			L415N/M	1.6	415			
			L450N/M	1.6	450			
			L485N/M	1.6	485			

MDP = max. design pressure

R_{min} = min. bending radius (in m)

R_p = yield strength (in N/mm²)

D_a = outside diameter (in mm)

S = safety factor

2 Segment and bevel cuts

Segment and bevel cuts are permissible to max. 7.5° per pipe end for gas line pipe within the pressure range up to 5 bar and max. 2.5° for gas line pipe within the pressure range up to 16 bar. For water line pipe, max. 7.5° per pipe end (i.e. a total of 15° per joint) is permissible.

3 Field bends

Steel pipe without cement mortar lining can be cold bent on site to a max. of 1.5° per bending step of 1 x D_a (corresponding to a bending radius of approx. 40 x D). For pipe with an additional FCM top coating, the deflection should be limited to a maximum of 1.0° per bending step.

Coating Test

Before plastic-coated pipes (or pipeline sections) are lowered into the trench, they must be examined for coating holidays with the help of a high-voltage tester. The test voltage should be at least 5 kV plus 5 kV per mm coating thickness up to a maximum of 20 kV.

Any coating holidays detected must be repaired e.g. with plastic coating repair sets, following the manufacturer's instructions.

Repairs

Polyethylene coating

Defects or holidays in the polyethylene coating as a result of transport or handling must be repaired in accordance with the specifications of DVGW Worksheet GW 15.

Depending on the defect size, repair patches or materials that conform to DIN 30672 can be used. It is advisable to use a repair patch for small flaws. There must be an all-round overlap of 50 mm over the mill-applied coating:

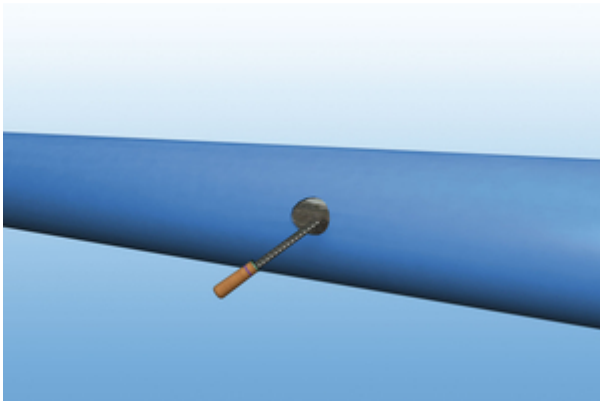

1. Remove dirt, rust and grease, cut off loose edges and smooth out notches and cuts in the coating with abrasive cloths or a rasp.

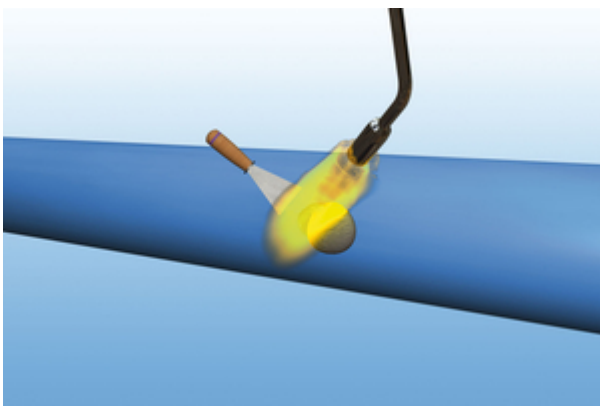

2. Heat the defect site and stop any holes with the accompanying filler. If necessary, smooth the surface with a stopping knife.

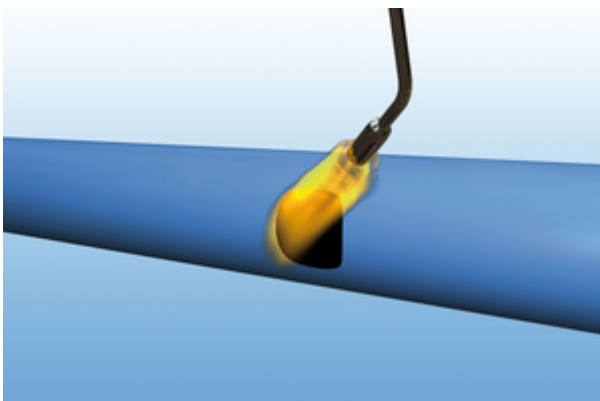

3. Heat the adhesive side of the patch, then apply it to the repair site. Heat with a gentle propane flame and use a glove or a roller

to press the patch until it is smooth and free of air bubbles.

Fiber cement mortar (FCM) coating

Flaws in the FCM coating can be repaired by wrapping cement or polyurethane tapes around the pipe so that they cover the flaws. See "[Field coating](#)".

Cement mortar (CM) lining

A cement-mortar mixture based on Portland cement (CEM I) is used for repairing defects in the cement-mortar lining and for field lining pipe or fitting surfaces (see list of accessories: Isomix):



1. The mortar is supplied dry in 10 kg buckets. Before use, add the necessary amount of water and mix until homogeneous.

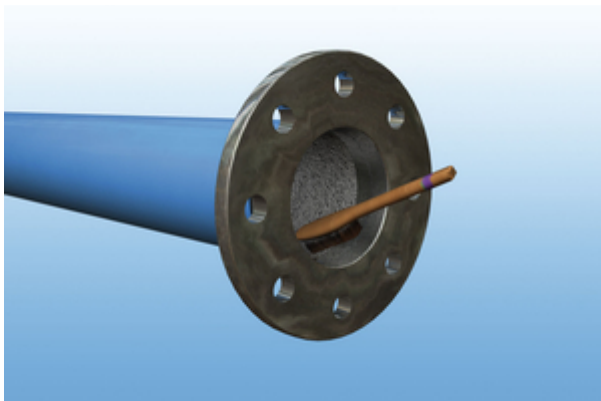

2. Brush the surface clean and moisten it so that the mortar will bond adequately when it is applied.

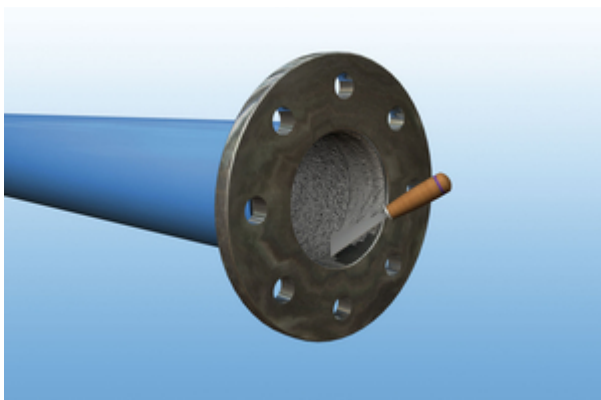

3. Use a trowel to apply and smooth the mortar. The temperature should be above 5 °C during the repair and while the mortar is curing (frost-free storage).

To ensure that the lining cures properly, especially at high temperatures, it is advisable to cover the lined area with, for example, plastic sheeting or to keep the surface damp. The cement-mortar must be allowed to dry for at least 24 hours before welding is carried out.

Trenchless pipe-laying

For the various trenchless pipe-laying methods pipes with both plastic coating and an additional fiber cement mortar top coating are used. The coating to be selected depends on the installation stresses. In stony or rocky soils in particular, the pipe should be protected by an FCM-S coating.

Otherwise, the pipes are handled in basically the same way as with open trench pipe-laying. Care must be taken not to exceed the permissible elastic bending radii and the maximum tensile forces.

As a rule, shortened pipes are not used in trenchless pipeline sections. We can show you the appropriate procedure for exceptions to the rule.

[Pipe end design](#)

Your contact for trenchless laying

Mannesmann Line Pipe GmbH

Thorsten Schmidt

Phone: [+49 271 691-180](tel:+49271691180)

thorsten.schmidt@mannesmann.com

Field coating / top coating

Comparison of curing times and strengths

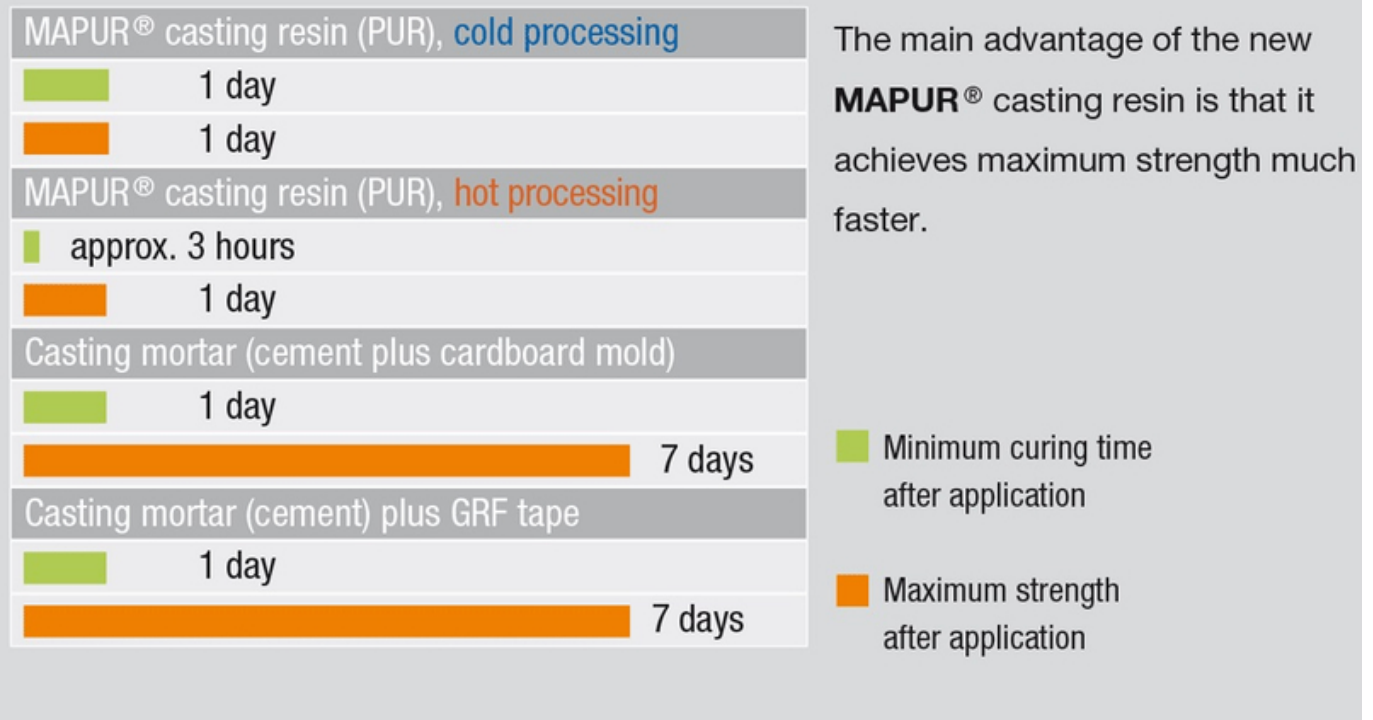

To ensure that plastic coated pipes have the necessary load-bearing strength, they should be field coated with a three-layer system (heat-shrink tubes or collars with an additional epoxy resin primer) or a duromer system (polyurethane or GFR laminates). Alternatively, a coating system compliant with DIN 30672 or DIN EN 12068 can be combined with a GFR coating. The field coating should be flush with the mill-applied coating.

The joint areas of FCM coated pipes are field coated as usual with field coating material conforming to DIN 30672 or DIN EN 12068. Casting mortar (see "[FCM coating](#)") is used for mechanical protection. Where stresses are very high or time is at a premium (MFR coatings usually need at least 24 hours to set), an alternative or additional coating is also available here, namely with GFR material or polyurethane tapes. This raises the mechanical load-bearing strength and allows the setting time to be correspondingly shortened.

FCM coated pipes are not suitable for trenchless pipe-laying with a driving technique (e.g. pipe ramming or thrust boring) since this could destroy the adhesive bond between the plastic coating and the FCM top coat.

FCM coatings have a coarser surface than plastic coatings and they are hygroscopic. If required, the top coat can be pre-treated to reduce friction on the pipe surface before it is drawn in.

With FCM top coats, just as with plastic coatings, the transition area between the mill- and the field-applied coatings must be as even as possible without any great cross-sectional variations. So careful application of the field coating systems is very important.

Coating systems that provide exactly the required level of mechanical protection are available for every application profile. It is therefore possible and essential, especially in trenchless projects, to rule out excessive loads on the coating, e.g. when drawing in

a pipe string on a roller system. The use of point supports for complete string sections is impermissible.

The coating products MAPUR[®] and MAPUR2012[®] were developed specifically for the new systems used in trenchless pipe-laying (e.g. FZM-S or multi-layer coating systems). Supporting the systems approach, they provide optimum protection in demanding pipeline construction projects.

For our systems approach (steel pipe with mill-applied coating and suitable field coating of the joint areas), we cooperate with Schneider & Co. Protec Service (<http://www.schneider-co.eu/>).

Pipe end design

As a rule, shortened pipes are not used in trenchless pipeline sections. We can show you the appropriate procedure for exceptions to the rule.

On-site manufacture of shortened pipes is shown in the PDF file which you can download below.

1 Required tools

- Angle grinder with cutting disc for grinding off the T-profile with adhering mortar
- Scrub disc or rotary steel brush to remove the epoxy resin primer and the adhesive layer
- Blow torch for preheating the pipe end
- Hammer and chisel for knocking off the mortar layer
- Knife for cutting through the PE/PP-coating

2 Procedure

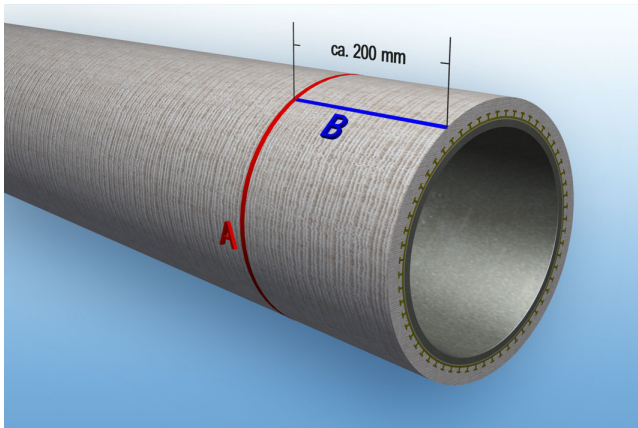

1. Mark circumferential cut A and longitudinal cut B.

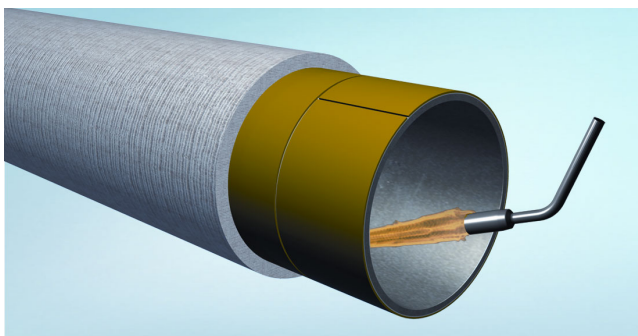

5. Use a blow torch to heat the pipe end from the inside to between 60 and 70°C. This is sufficient for stripping off the PE-coating.

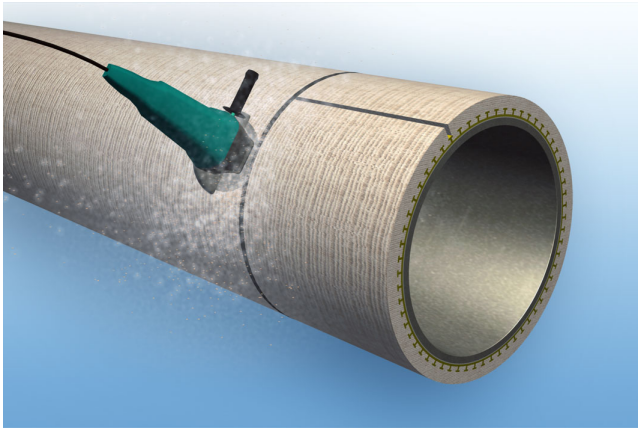

2. Use an angle grinder to cut through the FCM coating

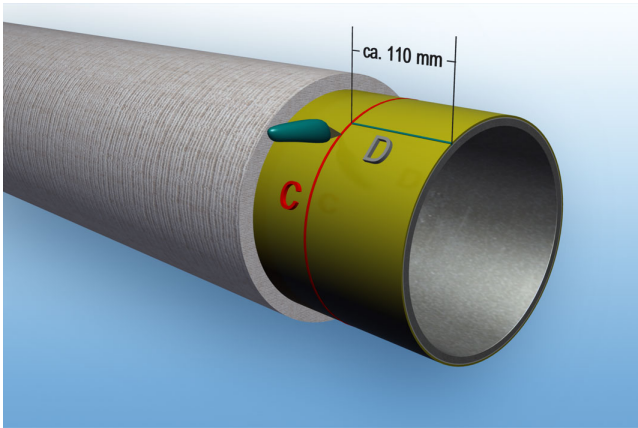

6. Use a knife to make a circumferential (C) and a longitudinal (D) incision into the plastic coating right down to the steel surface.

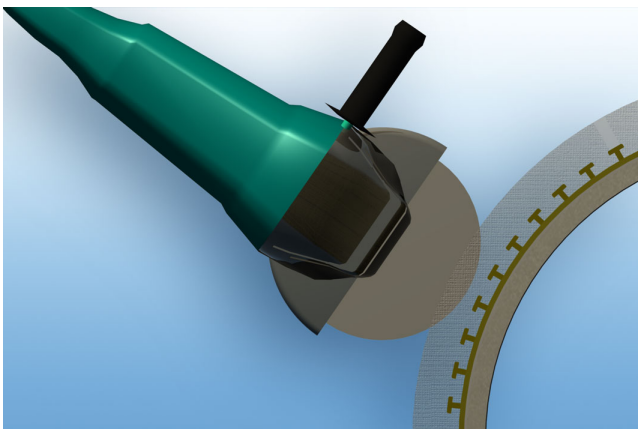

... down to the T-ripping, if possible.

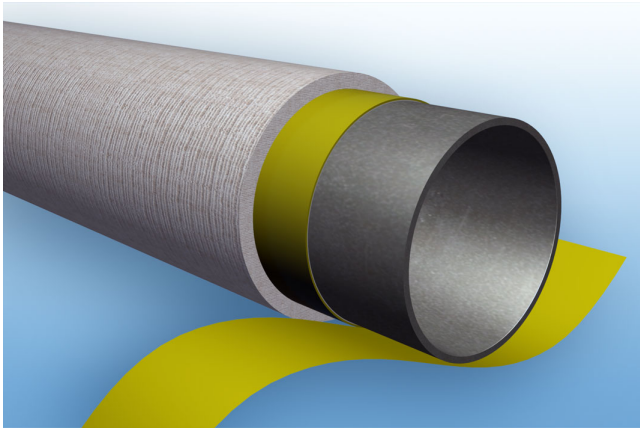

7. Strip off the PE/PP coating. If the temperature is right, the coating should come off easily and smoothly. If it tears, allow the pipe end to cool a little. If stripping is difficult, apply more heat to the pipe end.

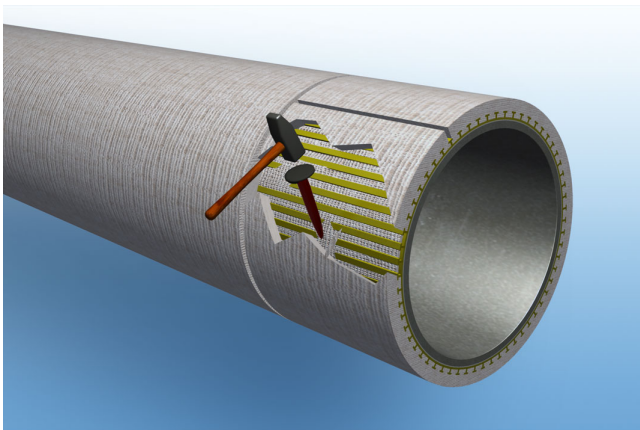

3. Knock off the cement mortar layer using a hammer and chisel.

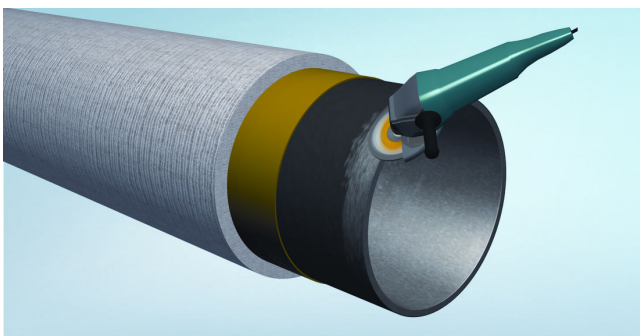

8. If required, use a scrub disc to remove any epoxy primer and adhesive residues.

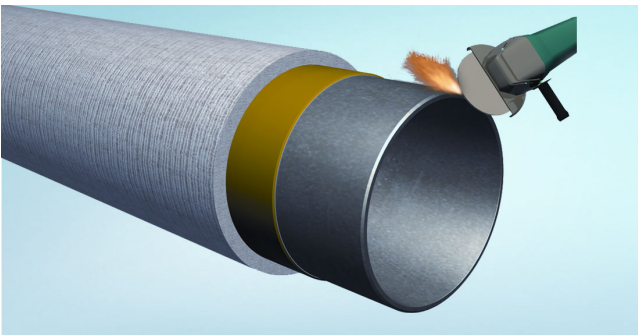
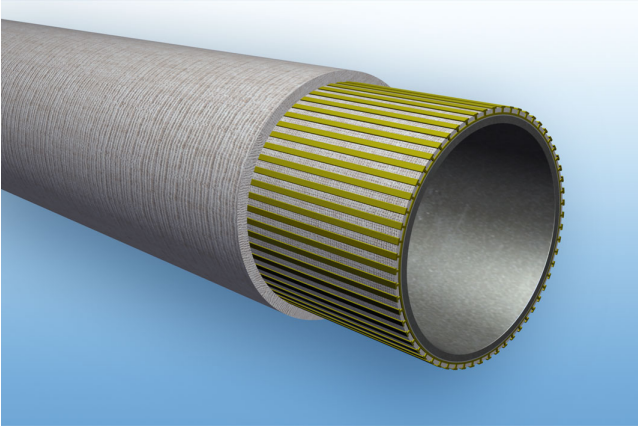

9. Bevel the pipe end as required. For butt-weld joints, use an angle grinder to cut a 30° bevel, leaving a residual web height of approximately 1.6 mm. Then use a rotary steel brush to bevel the PE/PP-coating.

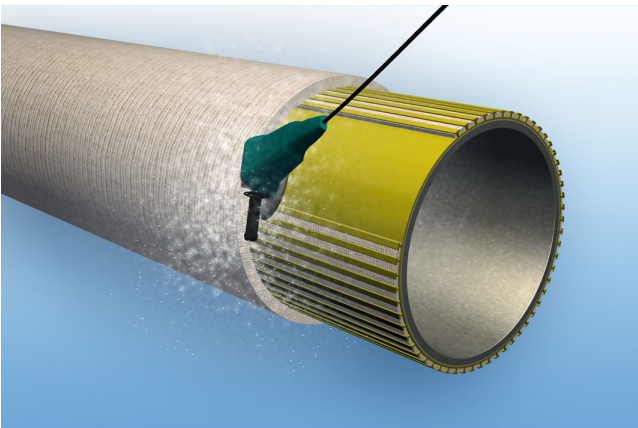

4. Grind off the T-ribbing to the level of the PE/PP coating with an angle grinder

Pressure test

The pressure test must be carried out in compliance with the requirements laid down in the relevant rules and regulations, e.g. for gas pipelines the DVGW Worksheet G 469 and/or the VdTÜV Data Sheet 1060 and for gas pipelines up to 16 bar, EN 12327.

The example set out below illustrates the pressure test for water pipelines in compliance with EN 805 and/or DVGW Worksheet W 400-2.

Each pipeline must be subjected to a pressure test after it has been laid. Pressure tests must be carried out by qualified personnel with the relevant knowledge of pipeline engineering, the execution of pressure tests, the measurement techniques and the applicable safety regulations.

Before the pressure test can be carried out, the pipeline must be covered with backfill material so as to avoid shifts in position, which could cause leaks. This applies in particular to pipelines with mechanical socket connections. The joints need not be covered by backfill. The pipeline is to be tested over its entire length or, if necessary, in sections. The test sections must be defined so that:

- the test pressure is reached at the deepest point of each test section
- and a pressure of at least 1.1 times the maximum design pressure (MDP) is reached at the highest point.

The system test pressure (STP) can be calculated on the basis of the MDP as follows:

- with calculation of the pressure surge: $STP = MDP + 1 \text{ bar}$
- without calculation of the pressure surge, $STP = MDP \times 1.5$, or $STP = MDP + 5 \text{ bar}$ (the lower value applies).

Before starting the test, the pipeline must be slowly and evenly filled with water at a rate of about 0.3 l/s (DN 100) to 6 l/s (DN 400) and the air must then be evacuated.

The pressure test is carried out in a maximum of three steps.

1. Preliminary test: To stabilize the pipeline section when the soil has finally settled and the cement-mortar lining has absorbed sufficient water. Water absorption in the cement-mortar pores may initially cause a drop in pressure even if the pipeline is completely watertight. For this reason it is advisable to carry out the pressure test over a period of at least 24 hours. The pressure must be brought back to the test level at regular intervals and in any case after a drop of 0.5 bar.
2. Pressure drop test: Determines the amount of air still in the pipeline. Carry out as specified by the planner
3. Main test: There are two basic test methods: the pressure loss method and the water loss method.

The main test is a test of the entire system, and in particular of the watertightness and proper execution and installation of the pipes, fittings, etc. It is carried out over a period of 3 hours (for pipes up to DN 400). The pressure loss may amount to:

- 0.1 bar at a system test pressure (STP) of 15 bar (MDP: 10 bar)
- 0.15 bar at a system test pressure (STP) of 21 bar (MDP: 16 bar), and
- 0.2 bar at a system test pressure (STP) of $MDP + 5 \text{ bar}$ (MDP: $>16 \text{ bar}$)

The water loss method (see DVGW Worksheet W 400-2) can be used as an equivalent alternative to the pressure loss method described above.

Saddle fittings

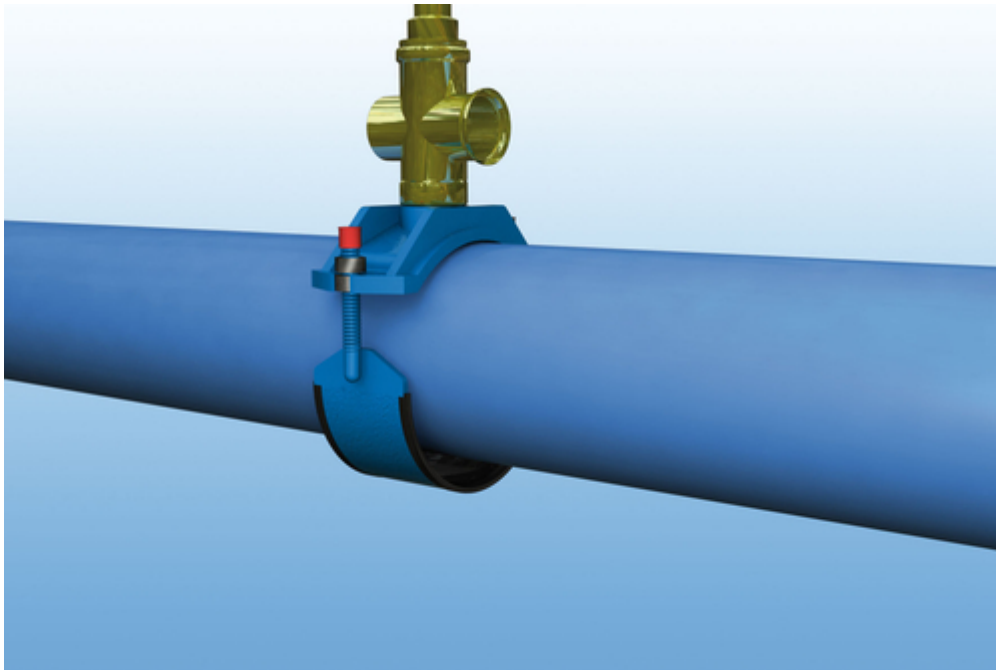

To fix a saddle fitting to a polyethylene coated pipeline, the polyethylene does not have to be removed at the site of the fitting. The additional FCM coating provides mechanical protection. Unless special tapping devices and saddle fittings are used, the FCM has to be removed before tapping.

The saddle fitting carrier bracket must be designed to avoid any damage to the corrosion protection system. A wide mounting piece exerts less pressure on the pipe surface.

Spiral drills made of tool steel or super high-speed steel, or carbide-tipped cutters are suitable for avoiding long chips. Tool steel, super high-speed steel or diamond-tipped bits are also suitable. All drill attachments must be suitable for drilling steel pipes (see manufacturer's specifications).

The tapping tool must allow the drill or milling cutter to be advanced slowly to avoid damaging the cement mortar lining.